

CORROSION -RESISTANT PUMP SERIES

耐腐蚀泵系列

NINGBO MELAN FOREIGN TRADE SERVICE CO.,LTD.
ZHEJIANG XINSHAN PUMPS CO., LTD (branch)

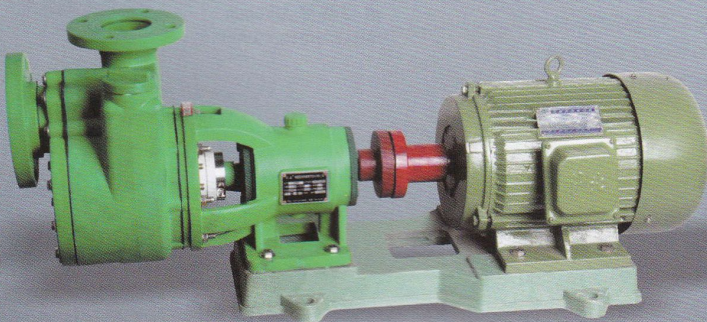
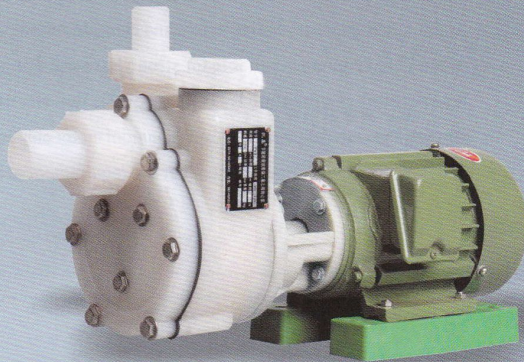
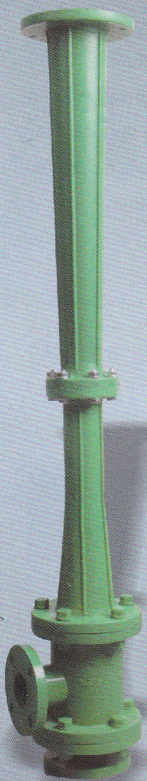
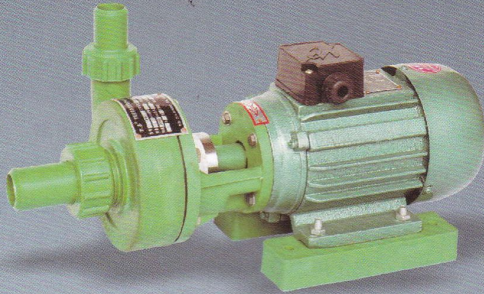

OTTIME PUMPS®



B 001

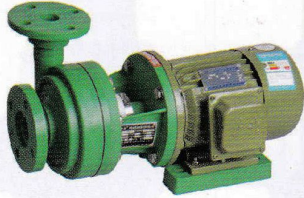

FP系列耐腐蚀离心泵(直接式)
Corrosion resisting plastics centrifgal pump (direct-like)

B 002

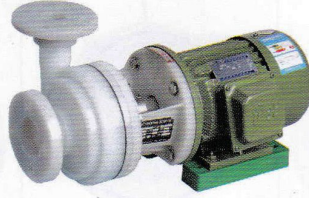

FV系列耐腐蚀离心泵(直接式)
Corrosion resisting plastics centrifgal pump (direct-like)

B 003



FP系列耐腐蚀离心泵(轴联式)
Corrosion resisting plastics centrifgal pump (axis joint ty

B 004



FV系列耐腐蚀离心泵(轴联式)
Corrosion resisting plastics centrifgal pump (axis joint type)

B 005



FP系列耐腐蚀自吸泵(轴联式)
Plastics centrifgal plastics pump(axis joint type)

B 006



FV系列耐腐蚀自吸泵(直接式)
Plastics centrifgal plastics pump(direct-like)

B 007

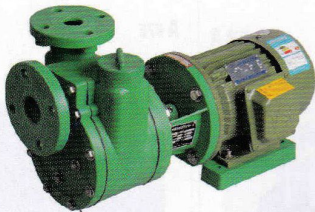

FP系列耐腐蚀自吸泵(直接式)
Plastics centrifgal plastics pump(direct-like)

B 008

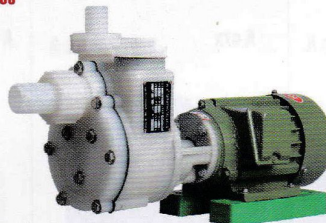

FV系列耐腐蚀自吸泵(直接式)
Plastics centrifgal plastics pump(direct-like)

B 008



全塑卧式成套真空机组
All models the horizontal-type complete vacuum unit

B 010

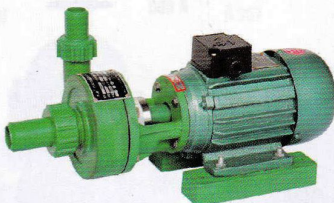

耐腐蚀自吸泵
Plastics centrifgal plastics pump

B 011



水喷射真空泵/汽水串连喷射泵
Water jet vacuum pump/Aerater water seriesconnection jet pump

B 012



水喷射真空泵/汽水串连喷射泵
Water jet vacuum pump/Aerater water seriesconnection jet pump

Corrosion Resisting Plastics Centrifugal Pump

耐腐蚀离心泵、自吸泵

Ottime pumps®

C

耐
腐
蚀
泵
系
列

PVDF(聚偏二氟乙烯)、FRPP(增强聚丙烯) 耐腐蚀泵系列产品技术说明

PVDF & FRPP Pumps specification

FRPP、PVDF

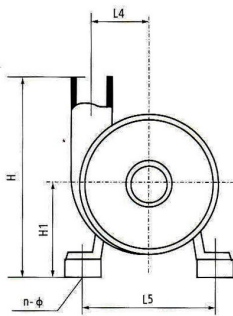
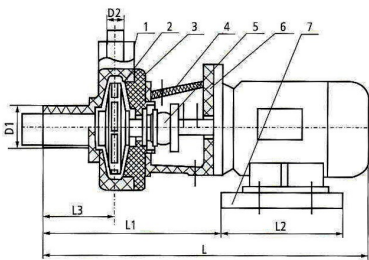
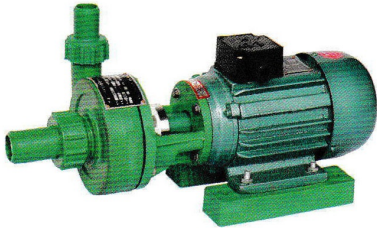

我厂专业生产PVDF、FRPP两种材质四个系列 (FV、FP、FVZ、FPZ) 的全塑耐腐蚀离心泵、自吸泵, 其中PVDF泵适用于强酸、强氧化剂、卤素、芳烃、脂肪、氯化溶剂等化学介质, 使用温度为-40~+140℃; FRPP泵适用于强碱及一般酸碱盐类及其衍生物, 使用温度为-14~+90℃。泵的传动一般供二极Y型节能电机, 如需安装防爆电机, 由用户提出; 对流量、扬程、转速、功率如有特殊要求, 我厂可以提供技术服务, 满足用户要求。

Listed is PVDF & FRPP plastic pumps made by the plant, there are four series (FV,FP,FVZ,FPZ) Centrifugal pumps and self-suction pumps. PVDF pump is suitable for strong acid, strong oxidant, halogens, aromatics, esters and chloride solutin, operating temperature is -40℃ ~ +140℃.FRPP pump is suitable for strong base and normal salts and it's derivatives, and it's operating temperature is -14℃ ~ +90℃. Two electrons Y-type energy saving motor was applied with the pump, the explosionproof motor only supplied with according requisition. The flow, lift, speed, power also meet the requirement of according requisition.

泵的型号说明 Pump type

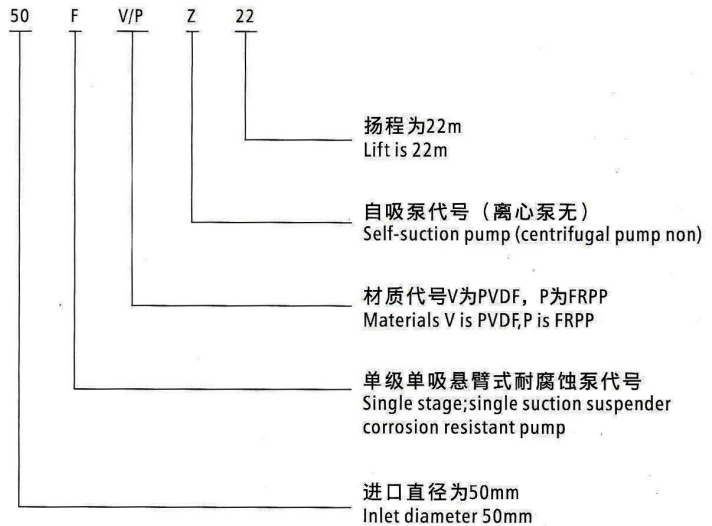

Corrosion Resisting Plastics Centrifugal Pump

耐腐蚀离心泵、自吸泵

Ottime pumps®

离心/自吸泵谱图

Centrifugal pump/self-suction pump flow graph

FRPP, PVDF

C

耐腐蚀泵系列

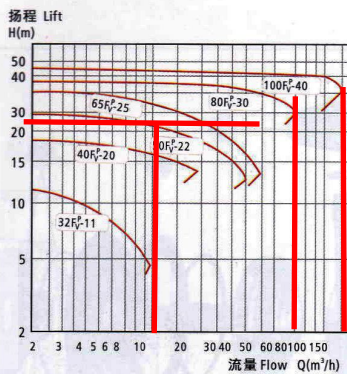

F系列耐腐蚀离心泵
F Centrifugal pump flow graph:

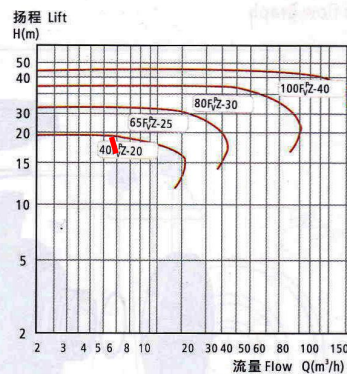

FZ系列耐腐蚀自吸泵谱图
FZ self-suction pump flow graph:

安装注意事项

Installation maintenance



- 1、泵经长途运输到达生产场地，安装前应开箱检验，泵机零部件是否完好无损，紧固件如有松动，应重新紧固，检查泵轴与电机轴的同轴度，如有松动应予校正。
- 2、泵体全部为PVDF、FRPP树脂注塑成形，输出管路上应有支撑架或吊架，不能全靠法兰承受压力，以防变形损坏；进口管路要尽量减少管路水力损失，90°弯头不应超过两个。FP、FV型离心泵应在吸入管前端装上底阀，以保证泵在启动前泵体内充满液体；吸入管口或底阀进口应装滤网，或在进口处装一个过滤器，以防止杂物吸入泵体，保证泵能正常运转。
- 3、泵体连接点螺栓要均力拧紧，进出口管连接严密，不能漏气，否则会影响抽真空，吸不出液体，或者造成流量、扬程不足等弊端。

1. The pump should be check before installation especially for the spare parts; shaft connection and locks should be a djusted on the right position tightly.
2. The body is made from plastics such as PVDF and FRPP, so the inlet and outlet pipe lines should have support or suspension structure, should not be supported only by the joint flanges. The inlet pipeline should not have more than tow 90° tures. And for centrifugal pump should have a bottom check valve at the inlet, and should have filiter before it also, so that the pump can have liquid being transferred before start up and without foreign item get into pump.
3. All connection should be tight and without leakage of air, otherwise the pump will not working properly and give the designed flow and lift.

Corrosion Resisting Plastics Centrifugal Pump

耐腐蚀离心泵、自吸泵

Ottime pumps®

C

耐腐蚀泵系列

离心/自吸泵谱图

Centrifugal pump/self-suction pump flow graph

FRPP, PVDF

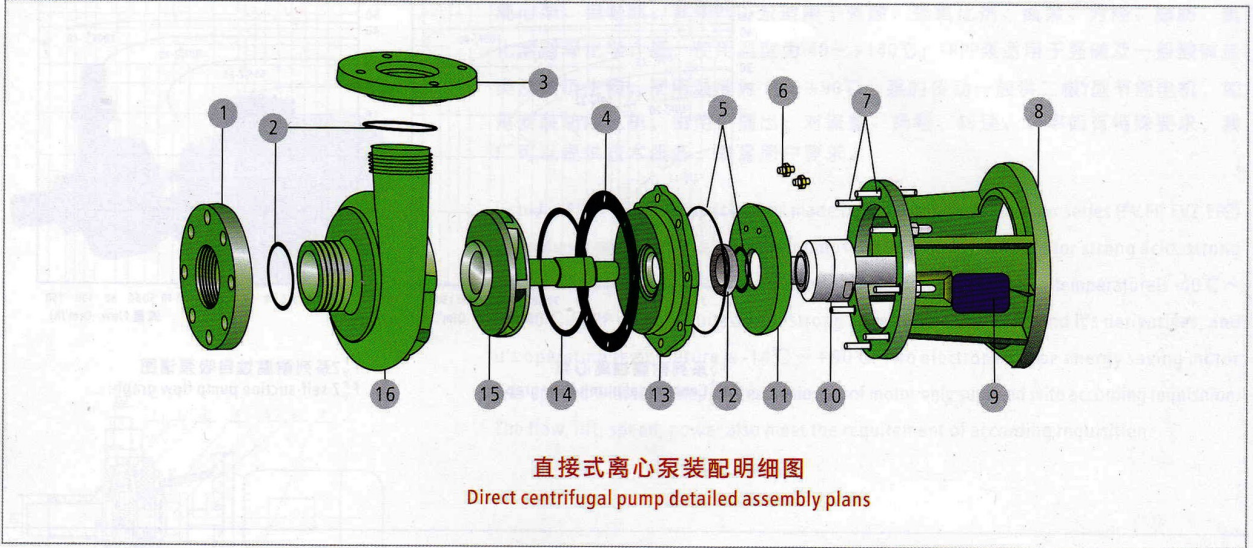

零件材质表 Part material list

序号NO.	名称 Name	材质 Material
1	进口法兰 Inlet flange	FRPP.PVDF
2	密封圈 Ring	EPDM.FPM
3	出口法兰 Pump Body	FRPP .PVDF
4	密封胶片 Seal film	EPDM.FPM
5	密封圈 Ring	EPDM.FPM
6	冷却水嘴 Cooling Water Cover	钢 Steel
7	双头螺柱 Double headed stud	钢、不锈钢 Steel,Stainless steel
8	支架 Support	FRPP
9	铭牌 Data plate	铝 Aluminum
10	机械密封动环 The mechanical seal moves	碳化硅 SIC
11	冷却盖 Cools the lid	FRPP .PVDF
12	机械密封静环 Mechanical seal static link	碳化硅 SIC
13	泵盖 Cover	FRPP .PVDF
14	密封圈 Ring	EPDM.FPM
15	叶轮 Impeller Shaft	FRPP/钢 Steel PVDF/钢 Steel
16	离心泵泵体 Centrifugal pump pump body	FRPP .PVDF

Corrosion Resisting Plastics Centrifugal Pump

耐腐蚀离心泵

Ottime pumps®

F_V^P系列耐腐蚀离心泵直接式
F_V^P direct connection type pumps installation chart

FRPP, PVDF



耐腐蚀泵系列

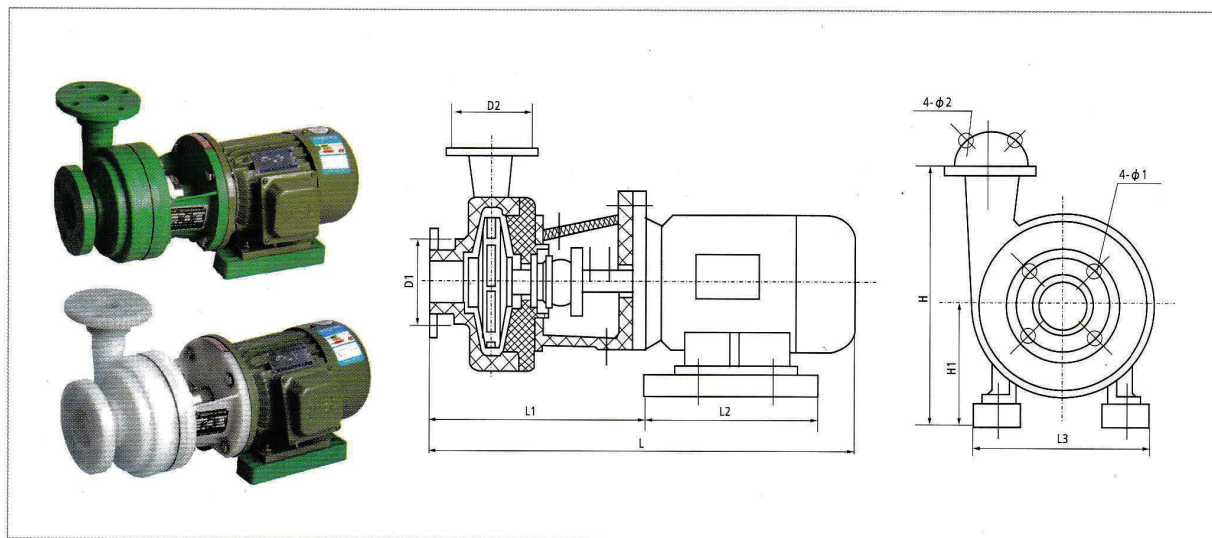

安装尺寸 Dimension list

单位 unit:mm

尺寸 Dimension 型号Type	直联式泵安装尺寸 Direct-coupled pump installed size						进口法兰 Import flange		出口法兰 Export flange	
	L	L1	L2	L3	H	H1	D1	4-φ1	D2	4-φ2
25F _V ^P (D)-8	400	180	145	110	197	95	25	缩节	25	缩节
32F _V ^P (D)-11	400	180	145	110	197	110	32	缩节	25	缩节
40F _V ^P (D)-18	510	235	145	140	280	130	110	4X14	100	4X14
50F _V ^P (D)-20 (22)	515	180	145	140	280	130	125	4X14	110	4X14
65F _V ^P (D)-25	640	380	140	300	285	120	145	4X16	125	4X16
80F _V ^P (D)-30	725	415	140	325	300	130	160	8X18	145	4X16
80F _V ^P (D)-32	725	415	140	325	300	130	160	8X18	145	4X16
100F _V ^P (D)-20	880	460	215	365	450	250	180	8X18	160	8X18
100F _V ^P (D)-40	880	460	215	365	450	250	180	8X18	160	8X18

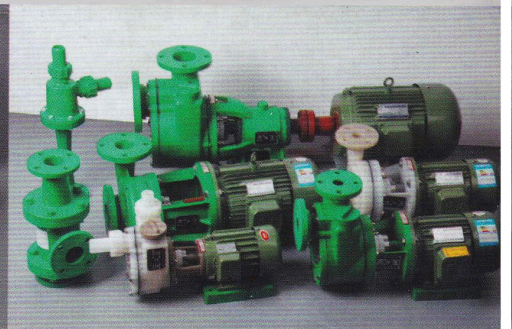
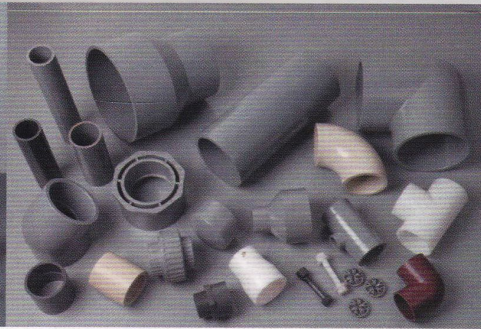

Ottimo pumps

RPP; PVDF; PPH, UPVC, CPVC

PLASTICS VALVES PIPE & PUMP SERIES

塑胶阀门/管道/泵系列

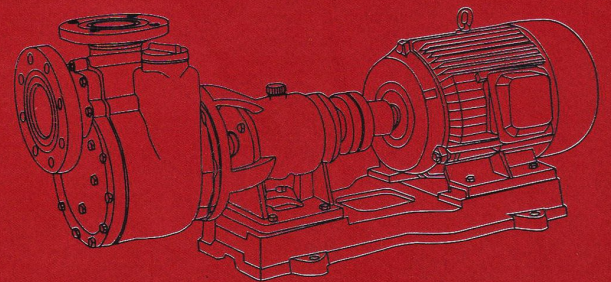
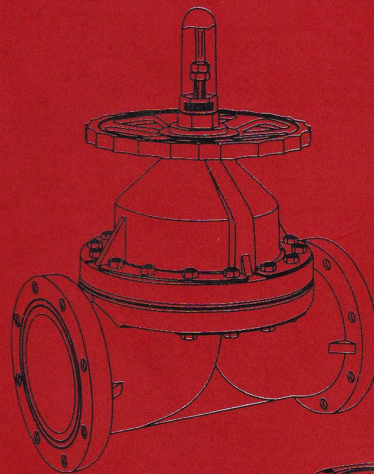

NINGBO MELAN FOREIGN TRADE SERVICE CO., LTD
ZHEJIANG XINSHAN PUMPS CO., LTD (BRANCH)